

# SANGEAN

ATS-818



# CONTENTS

---

Features -----	2
Control Locations -----	3
Choosing a Power Supply -----	5
Preliminary Settings -----	7
Tuning Modes -----	12
Clock Radio Operation -----	21
Special Tuning Techniques and Controls -----	23
Special SSB/CW Reception Techniques -----	26
Care and Maintenance -----	31
Specifications -----	33

# FEATURES

---

**Continuous Tuning** allows continuous reception of all stations and bands.

**Fast response, Three Color LCD**

indicates station frequency in large easy-to-read numbers, including dual time, memory location, signal strength and battery life.

**Direct Access Keypad** permits instant tuning of any desired frequency from 87.5 To 108MHz on the FM band and from 150 To 29.999KHz on the AM band.

**Forty-Five Memory Pre-sets** offer instant access to your favorite stations on LW, MW, FM and SW.

**AC/DC Power Supplies** for use virtually anywhere in the world.

**Special Tuning Controls** further improves radio reception.

**Dual Time Setting** allows you to pre-set your local time and UTC World Time, or any two time zones with instant recall.

**Scanning Circuit** permits you to check various frequencies on a certain bandwidth and lock on to it at random.

**Cancel Button** allows you to instantly change incorrect information keyde into the microprocessor.

**Band Select Buttons** offer instant selection of any desired frequency bandwidth on SW.

**Tuning Speed Selector Switch** permits you to tune stations at either a fast or slow speed.

**Sixty Minute Sleep Timer** will turn radio OFF at end of 60 minute elapsed.

**Standby Mode** turns on the radio automatically at a pre-set time either by buzzer or radio program.

**Stereo Headphone Jack** permits reception of FM multiplex stereo broadcasts.

**Folding Stand** allows you to position the radio either vertically or at an angle while maintaining stability.

**BFO Control** (Beat Frequency Oscillator) allows reception of SSB (Single Side Band) and CW (Continuous Wave Morse Code) transmissions.

# CONTROL LOCATIONS

1. Power On/Off Button
2. Display Light Button
3. Sleep Timer
4. Time Set
5. Dual Time Set
6. Dual Time Button
7. Manual Tuning/Auto Scan Button[ ∨ ]
8. Band Selectors
9. LCD Display
10. Meter Select Button
11. Frequency Select Button
12. Standby Button
13. Cancel Button
14. Enter Command Button.
15. Numeric & Bandwidth Button.
16. Memory Entry Button
17. Alarmed by Radio/Buzzer Selector
18. FM Stereo/Mono Mode Selector  
AM Narrow/Wide Mode Selector
19. BFO On/Off Selector
20. BFO Pitch
21. RF Gain Control
22. Tone Control
23. Telescopic Antenna
24. Rotary Tuning Knob.
25. Tuning Speed Control
26. Lock Switch
27. Volume Control
28. Carrying Handle
29. Folding Stand
30. 9kHz/10kHz Step Switch and  
Battery Compartment
31. AM External Antenna Jack
32. Stereo Headphone Jack
33. DC Input Jack/6 Volts

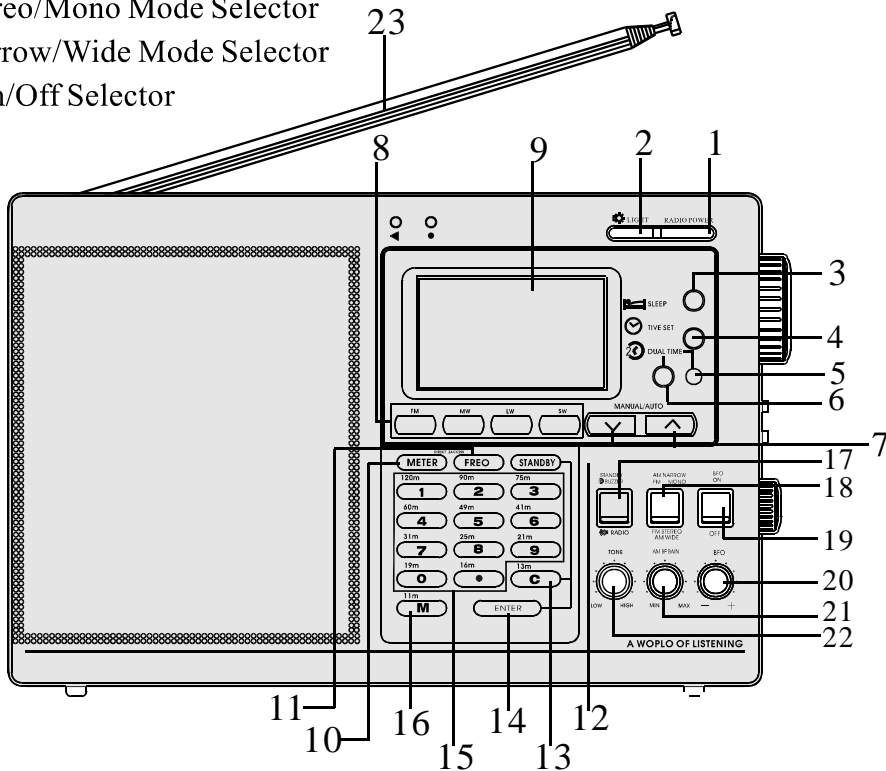

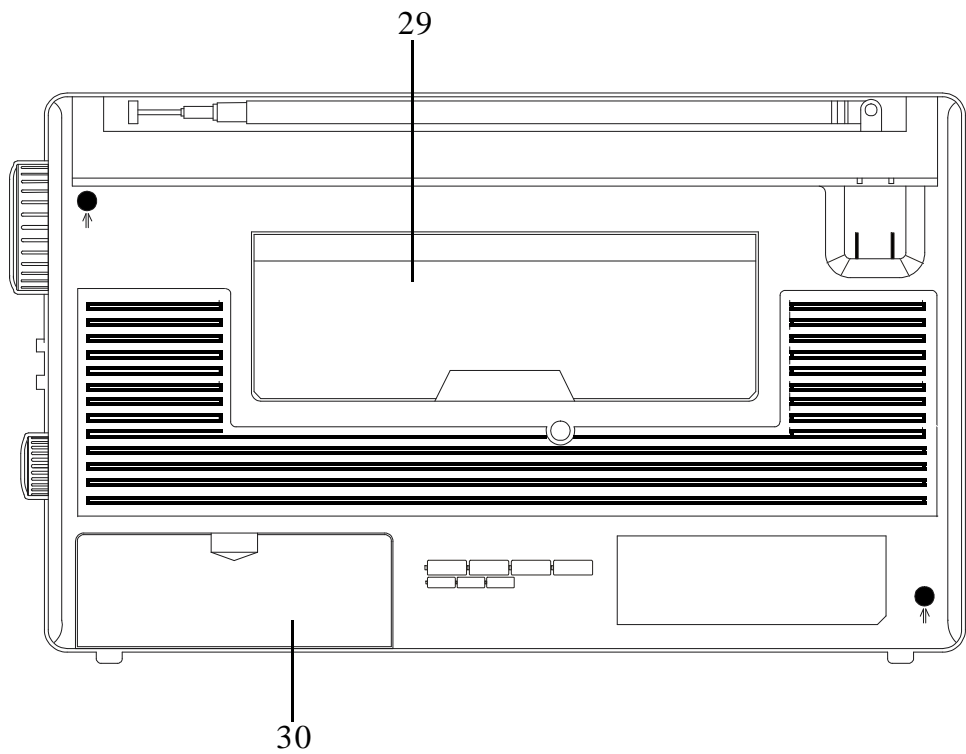
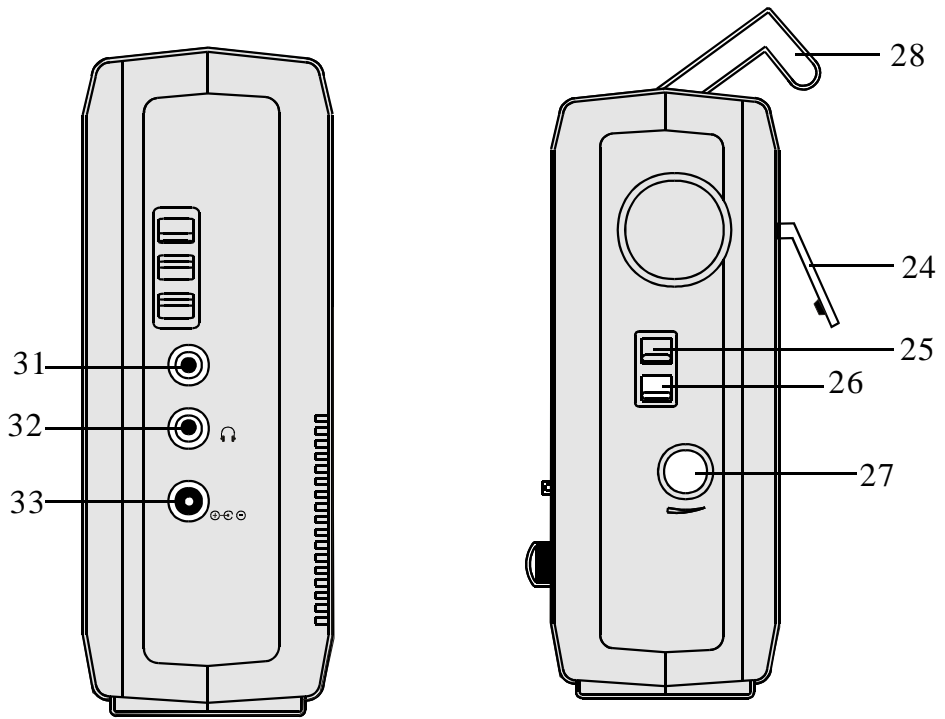

# CHOOSING A POWER SUPPLY

You can operate the receiver using:

- 4 Alkaline D size Batteries
- Household AC [With optional AC Adaptor]
- 12 Volt DC Automobile Battery [With optional DC adaptor]

## USING BATTERIES

1. Press latch marked OPEN on battery Compartment cover in the direction of the arrow and lift off cover.
2. Insert 3 “AA” batteries in the Back-up compartment and 4 “D” size batteries in the Radio compartment. Be sure to position them as illustrated on the back of the radio, and on top of the lift-out ribbons for easy removal.
3. Replace the battery compartment cover and press down until you hear it snap closed.

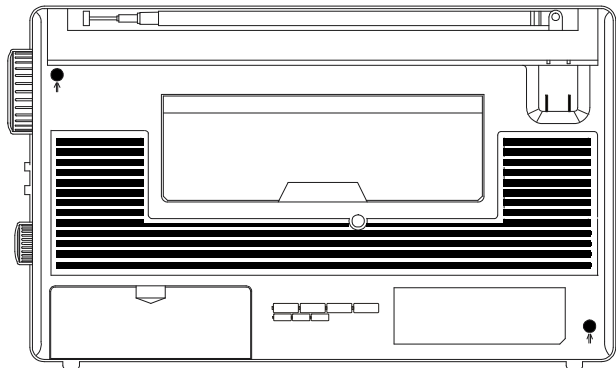
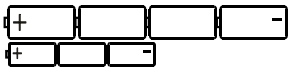
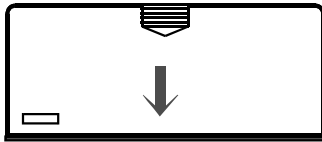

## NOTE

Whenever the radio is turned off, the battery Indicator will flash for about five seconds to Show battery condition.

If the indicator falls below #2, the 4 MAIN D size batteries should be replaced.

When the MAIN batteries become exhausted, the micro-processor will automatically be powered by the BACK-UP batteries.

When the display on the micro-processor begins to fade, replace the 3 AA batteries in the BACK-UP circuit. During battery replacement make sure the Lock Switch (26) is in the locked position . This will prevent any memory presets from being lost During the battery replacement. Battery replacement should be completed within 2 minutes.

---

## USING HOUSE CURRENT [AC]

The receiver may be powered by AC current  
Using the AC adaptor (not included). Insert  
The small barrel shaped plug into the jack on  
The side of the radio marked DC IN 6V.  
Plug the other end of the adaptor into a  
standard household outlet. Whenever AC  
is used, the batteries are automatically  
Disconnected.

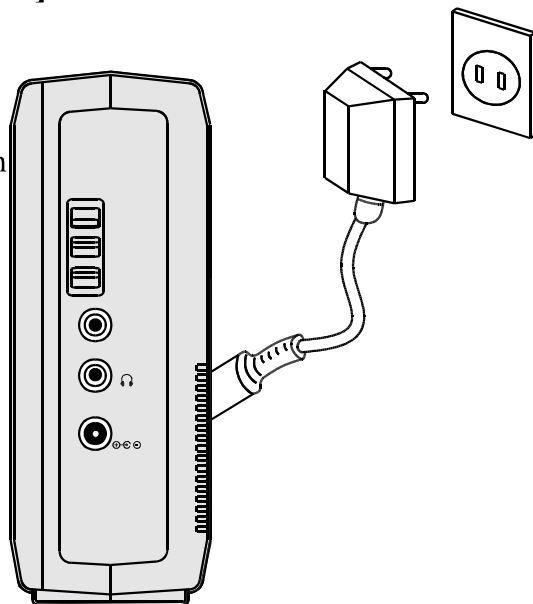

# PRELIMINARY SETTINGS

## SETTING THE CLOCK

The time is displayed in the 24 hour mode  
 Since most shortwave stations operate  
 According to UTC. This is the standard that  
 Is used throughout the world.

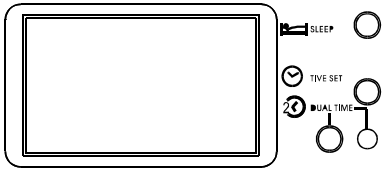
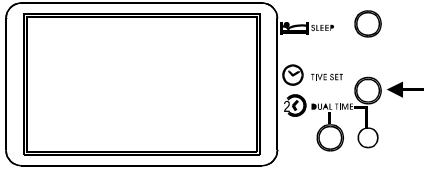
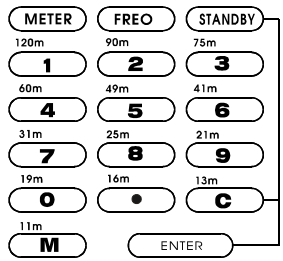
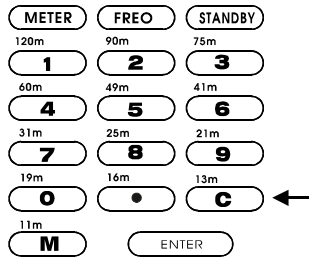
<p>The clock will start when 3 “AA” size batteries are installed. The display shows 0:00”</p>	
<p>1. Press TIME SET, 0:00 disappears &amp; for 12 seconds TIME SET Flashes.</p>	
<p>2. While FLASHING set the correct time by pressing the numbered buttons. As you press the corresponding button the number shows up on the LCD display.</p>	
<p>3. If you press the wrong number, press the C [CANCEL] button which deletes one number at a time. Repeat step #2 again.</p> <p><b>NOTE</b>  <b>Time can only be adjusted when TIME SET is in flashing mode.</b></p>	

4. Now press button marked ENTER .  
Display shows hours and minutes.

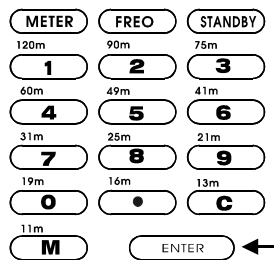

# SETTING DUAL TIME

A second time zone can be programmed  
 Into this unit such as your home time  
 If you are travelling , or UTC World Time for  
 Instant access to short-wave broadcasts or  
 The local time where ever you may be.

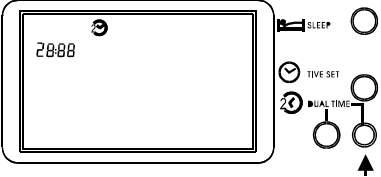
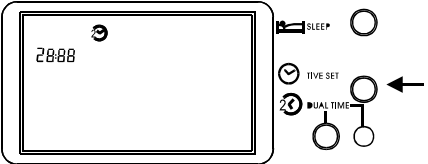
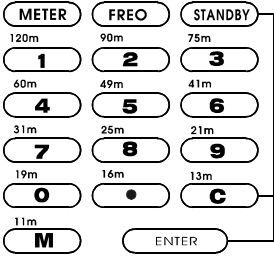
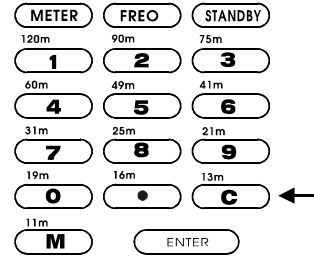
<p>1. Press right side "DUAL TIME" button then the display will show the secondary TIME and appears.</p>	
<p>2. Press TIME SET button Clock time will disappear &amp; "TIME SET" will flash for 12 seconds.</p>	
<p>3. While FLASHING set the correct time by pressing the numbered buttons. As you press the corresponding button the number shows up on the LCD display.</p>	
<p>4. If you press the wrong number, press the C [CANCEL] button which deletes one number at a time. Repeat step #3 again.</p>	

5. Now press button marked ENTER ,  
Display shows hours and minutes.

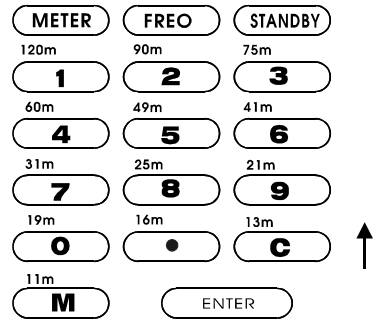

6. By pressing the right side DUAL TIME button now, the LCD display will once again show the clock time.

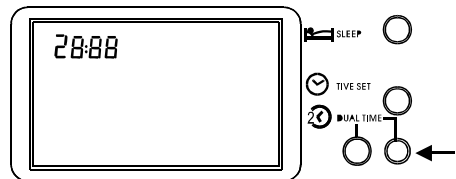

7. To verify DUAL TIME ,press the left side DUAL TIME button to display your "OTHER" time zone. When you release the button the clock will show your current local time.

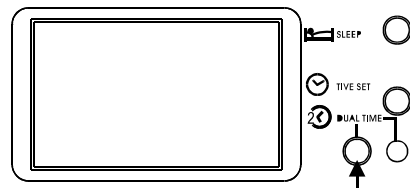

# BAND SELECTION

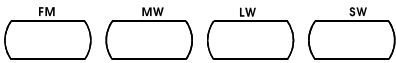
<p>There are four band selector buttons located just beneath the LCD display.</p>	
---	--

BAND	FREQUENCY RANGE	PROGRAM TYPE
FM	87.5~108 Mhz	Standard FM
LW	150~519 KHz	Longwave
MW	520~1710 KHz	Standard AM
SW	1.711~29.999 MHz	SW/13 Sub-Bands

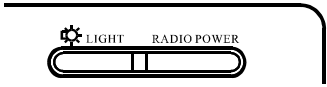
<p>1. Turn radio on by pressing POWER button. Display will show last band and frequency selected.</p>	
---	--

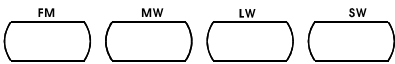
<p>2. By pressing any one of the four band selector buttons the display shows the band selected and a random frequency within that band.</p>	
--	--

**NOTE**

When you select SW you only have to press the button marked **METER**, and then any one of the numbered buttons depending upon what band you want to listen to. The Display will show the band you selected and a random frequency within that band.

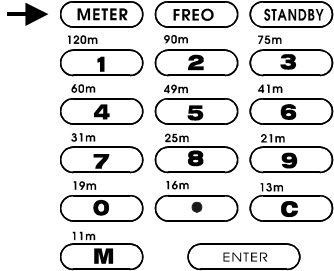

# TUNING MODE

## ADJUSTING THE ANTENNA

Locate the band you want to listen to in the

Following chart and adjust the antenna as

indicated

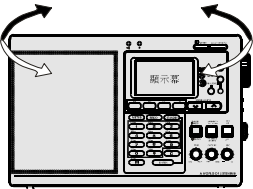
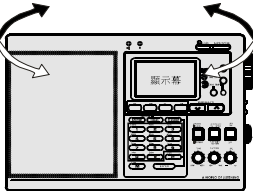
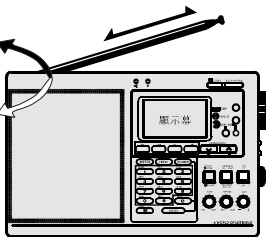
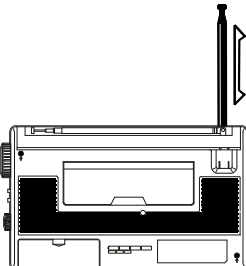
BAND	FREQUENCY RANGE	ANTENNA TYPES	ILLUSTRATION
MW	520-1710 Khz	INTERNAL Rotate radio for best reception	
LW	150-519 Khz	INTERNAL Rotate radio for best reception	
FM	87.5-108 Mhz	TELESCOPIC Extend antenna all the way & rotate it for best reception	
SW	1.711-29.999 Mhz	TELESCOPIC Extend antenna all reception & <b>do not rotate</b>	

You may select any frequency using four different tuning methods:

- Direct Tuning**
- Manual Tuning**
- Scan Tuning**
- Memory Tuning**

## DIRECT TUNING

You may KEY IN a specific band (120m, 49m,16m)by pressing the appropriate button. The exact station is then selected by pressing the buttons corresponding to the station frequency.

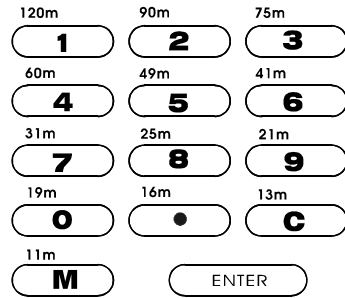

**Example:** To tune 100.70 MHz on the FM band, follow this procedure:

1. Press the POWER button to turn on the radio.

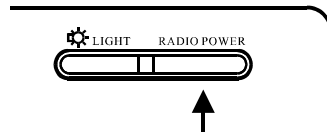

2. Press the button marked, FREQ (Frequency)



3. Press the corresponding buttons, marked [1],[0],[0],[.],[7],[0]. That exact frequency will now show up in the display.

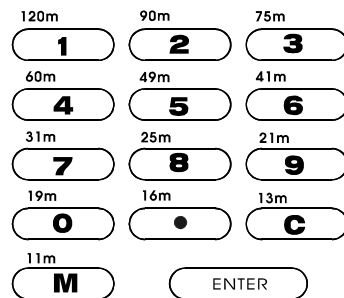

4. Press the button marked ENTER within twelve seconds. The frequency and band will now show up in the display. The SIGNAL STRENGTH will also show.

**NOTE:** Be sure to press the decimal point [.] in 100.70MHz, otherwise the display will show SW ,[10.070 MHz] automatically.

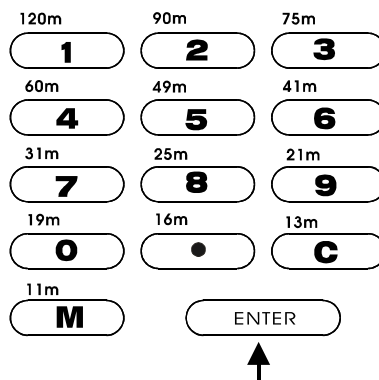

5. Extend the antenna all the way and rotate for best FM reception.

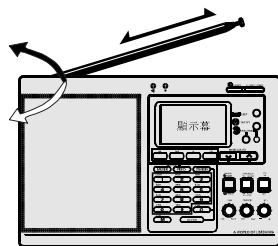

6. Adjust the VOLUME and TONE controls for the desired sound.

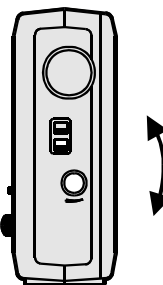

7. When selecting a stereo FM station make sure the FM mode switch is in the STEREO position.

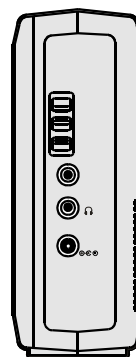

# MANUAL TUNING

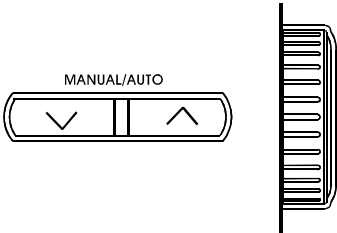
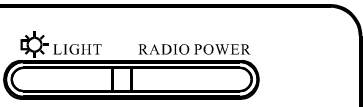
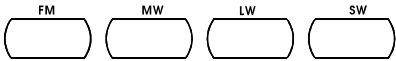
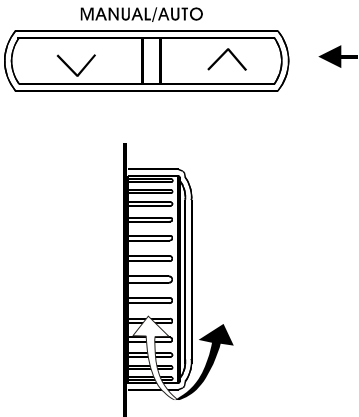
<p>To select a station you do not know the Frequency of, use the MANUAL TUNING[∨] buttons or the ROTARY TUNING control on the side of the radio.</p>	 <p>The diagram shows a horizontal control panel with a central vertical bar. To the left of the bar is a downward-pointing chevron (∨) and to the right is an upward-pointing chevron (∧). Above the bar is the text 'MANUAL/AUTO'. To the right of the panel is a vertical rotary tuning knob with multiple horizontal ridges.</p>
<p>1. Press the POWER button to turn on radio.</p>	 <p>The diagram shows a horizontal control panel with a central vertical bar. To the left of the bar is a gear icon and the text 'LIGHT'. To the right of the bar is the text 'RADIO POWER'. The panel is shown as part of a larger device with a curved edge on the right.</p>
<p>2. Select a band.</p>	 <p>The diagram shows four horizontal buttons arranged in a row. Above each button is a label: 'FM', 'MW', 'LW', and 'SW' from left to right.</p>
<p>3. Press repeatedly the[∨] buttons to reach a desired frequency. Press and hold the [∨] buttons for at least a half second or more to change frequencies rapidly.</p> <p>OR Rotate the TUNING knob until the desired frequency or station is tuned in using the SIGNAL STRENGTH INDICATOR in the display for the best Reception.</p>	 <p>The diagram shows the same horizontal control panel as in the first row, with the text 'MANUAL/AUTO' above it. A black arrow points to the right from the right side of the panel. Below the panel is the rotary tuning knob. A white arrow points upwards from the bottom of the knob, and a black curved arrow indicates the knob is being rotated clockwise.</p>

## NOTE

When you repeatedly press the [ √ ] buttons, the frequencies change in increments of :

FM: 50 kHz (or 100 kHz)

LW: 9 kHz

MW: 9 kHz or 10 kHz

SW: 5 kHz

Tuning the ROTARY TUNING Knob with The TUNING SPEED CONTROL set on FAST will change each band as follows:

FM: 100 kHz

LW: 9 kHz

MW: 9 kHz/10 kHz

SW: 5 kHz

When set on SLOW the frequencies change as follows:

FM: 50 kHz

LW: 1 kHz

MW: 1 kHz

SW: 1 kHz

With the TUNING SPEED CONTROL set on LOCK, ROTARY TUNING will not function.

4. Adjust the VOLUME and TONE controls as you like.

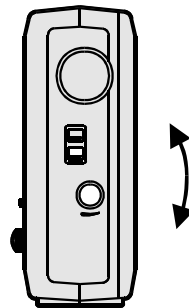

# SCAN TUNING

Use scan tuning to quickly locate a station  
Or to monitor several stations within a  
Specific band.

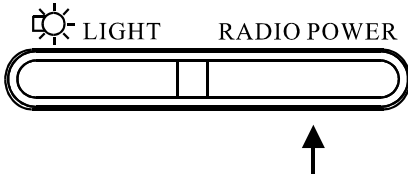
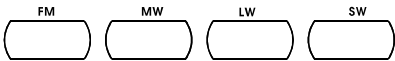
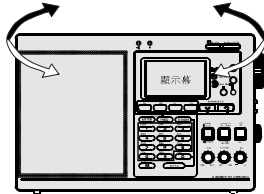
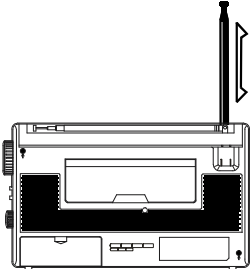
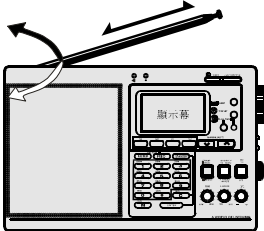
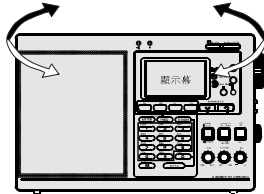
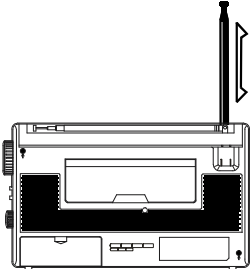
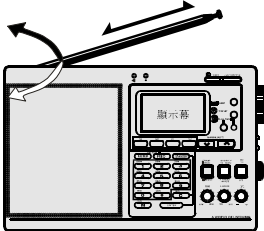
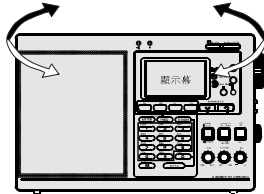
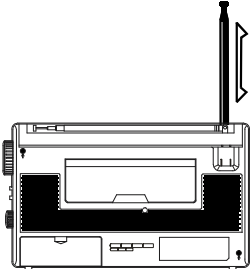
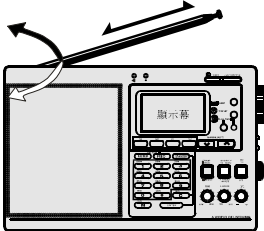
1. Turn on radio by pressing POWER button.					
2. Select a band.					
3. Adjust antenna or radio position depending on selected band.	<table border="1"><tr><td data-bbox="637 959 965 1340"><p>AM</p></td><td data-bbox="965 959 1289 1776"><p>SW</p></td></tr><tr><td data-bbox="637 1340 965 1776"><p>FM</p></td><td></td></tr></table>	<p>AM</p> 	<p>SW</p> 	<p>FM</p> 	
<p>AM</p> 	<p>SW</p> 				
<p>FM</p> 					

4. Press and hold the [ √ ] buttons for at least a half second or more and the radio will scan all the frequencies in that band, and will stop automatically each time it lands on an active station. Signal strength is recorded on the SIGNAL STRENGTH INDICATOR.

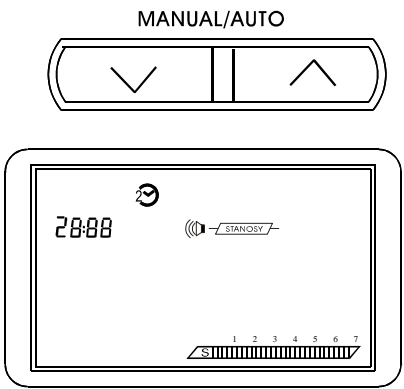

5. Press and hold the [ √ ] buttons again to resume scanning. When you reach the upper or lower limits of the band, the scanning starts all over again as long as the button is depressed once more.

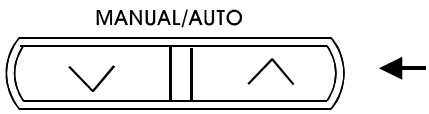

6. Adjust the VOLUME and TONE controls as you like.

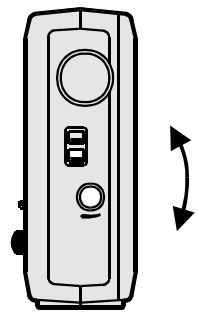

---

---

# MEMORY TUNING

You may store up to eighteen different Frequencies on the SW band and up to nine Different frequencies on each of the other Bands for instant selection of your favorite Stations.

## Storing a Frequency

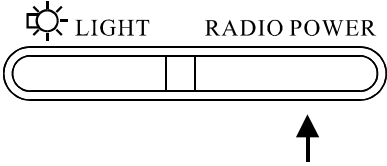
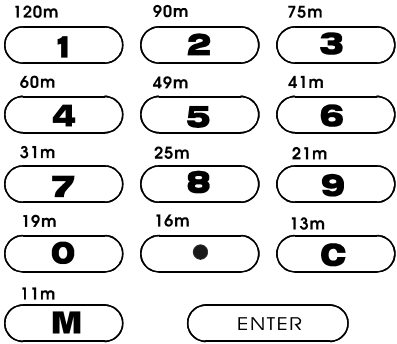
<p>1. Press POWER button to turn on radio</p>	
<p>2. Turn to any frequency using any of the previously mentioned tuning methods.</p>	
<p>3. Press the button marked M for MEMORY it will start flashing in the Display for 15 seconds during which time press any of the buttons marked 1-9 on the keyboard and your station will be Stored in that memory position. For the SW band frequencies press 1-9 and then 01-09 for a total of 18 SW memory positions. The display will show the memory position the station is now stored in. <b>You may store your stations in any sequence you want. You do not have to start with #1.</b></p>	

# RECALLING A FREQUENCY

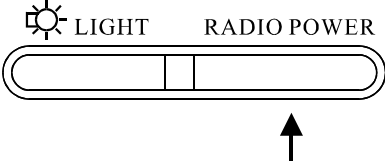
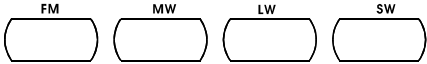
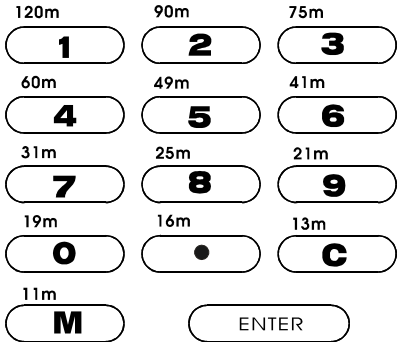
<p>1. Press POWER button to turn on radio.</p>	
<p>2. Select a band in which a station is stored that you want to recall.</p>	
<p>3. Press any of the NUMBERED buttons for A desired station and the radio will instantly tune to it and display that frequency and the MEMORY position number. If you want to Change to another stored station, just press Any other numbered button for access.</p>	

# CLOCK RADIO OPERATION

With this receiver you can fall asleep to your Favorite station by pressing the SLEEP Button, or wake you to the morning news, Or an alarm buzzer .**Make the following Settings with the POWER off!**

## Setting the Alarm

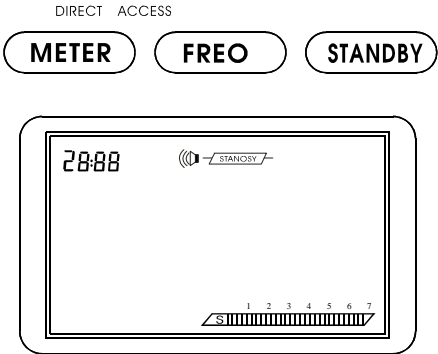
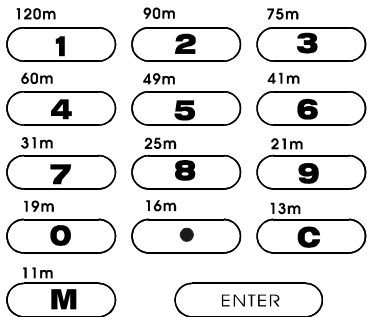
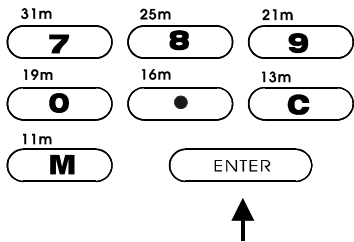
<p>1.Press STANDBY button so display shows 0:00.STANDBY will flash for 15 seconds.</p>	
<p>2.Press the numbered buttons to activate turn-on time using 24 hour time . in hours and minutes .For example, to set the radio to turn on at 1:30 PM each day, press the buttons until the display shows 13:30.<b>If the wrong number was keyed-in ,delete it by pressing the CANCEL button marked C . One time for each number .Then press the correct number for the time you want.</b></p>	
<p>3.When you reach your desired turn-on time, press ENTER, STANDBY stops flashing, your turn-on time is locked in. For 2 to 3 seconds, the clock returns to The current time automatically.</p>	

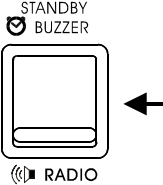
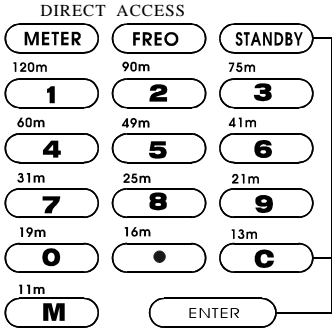
<p>4.To verify, press STANDBY button again. Press STANDBY once more and the clock Returns to the current time.</p>	
<p>5.You may select radio or buzzer alarm to wake you by setting STANDBY:BUZZER/ RADIO selector switch.</p>	
<p>6.To cancel the ALARM time, press STANDBY and C [CANCEL] button.</p>	

## Setting the Sleep Timer

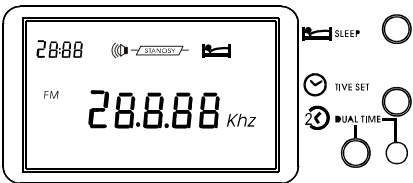
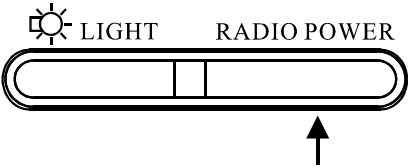
<p>1.Press SLEEP button. The icon  shows above the frequency read-out in the display. That's all there is to it.</p>	
<p>2.To turn off the radio before it automati - cally turns itself off, press the POWER button.</p>	

# SPECIAL TUNING TECHNIQUES AND CONTROLS

In addition to the standard tuning operations described previously, use the following controls for special operations.

## RF GAIN CONTROL

This control adjusts the receiver's sensitivity. For LW, MW, SW reception, rotate the control to the MAX position, this provides the maximum sensitivity. When you listen to the MW, standard AM band, or LW Band through external antenna, rotate the control only as far as needed to obtain a good signal. If you turn the knob further you might hear a distorted signal. For weak stations, rotate the control to the MAX position.

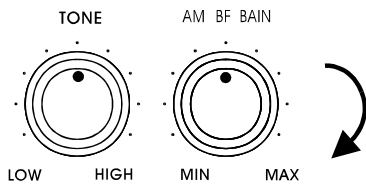

If you encounter interference, adjust the control in both directions until you obtain the best compromise between your station and the interference.

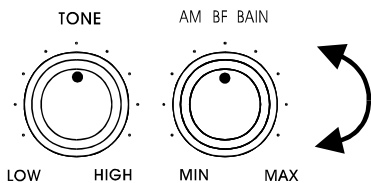

## AM NARROW/WIDE SELECTIVITY SWITCH

Some stations transmit their signal so that very little space exists between their airspace and the station next to them on the band. If while tuning, you encounter interference, caused by the signal from an adjacent station, press the button for the band you are listening to and select the NARROW position. The interference is reduced or muted.

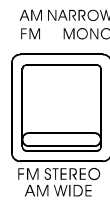

For full reception, leave the switch in the WIDE position.

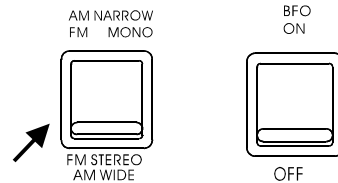

If you plan to listen to Morse code, referred to as CW (continuous wave), set the BFO Switch to ON position. If you encounter too much noise as you tune, set the AM NARROW/WIDE switch to NARROW position.

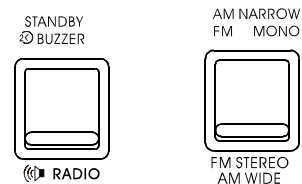

---

---

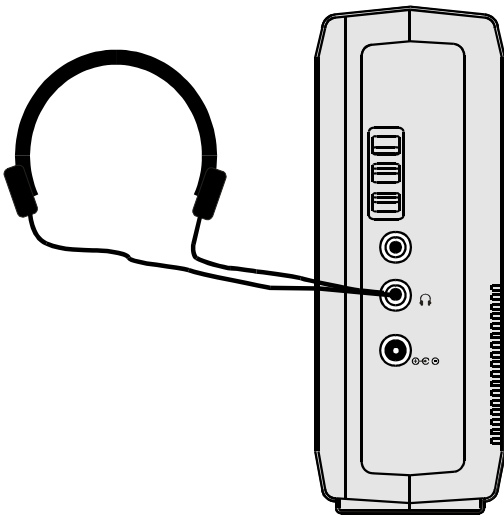

## HEADPHONE USE

While not a control, you may consider using HEADPHONES to obtain the best audio Clarity when listening to SW. Since many SW stations broadcast only marginal Signals, using HEADPHONES will enable You to distinguish between the signal and the noise usually encountered at night. Be Sure that the HEADPHONES terminate in a 1/8 inch plug, which is inserted into the HEADPHONE jack located on the left side Of the radio marked with the symbol  When the HEADPHONES are plugged in, The speaker is muted.



Because the radio is capable of receiving FM multiplex stereo, Stereo HEADPHONES Should be used. When listening to stereo FM, be sure that the FM: STEREO/MONO switch is set to the STEREO position.

## LOCK SWITCH USE

Using the LOCK switch prevents Unauthorized operation of the radio And will also prevent the station you Are listening to from being changed. When the LOCK switch is moved to Its up  position, the POWER button And TUNING controls are completely Disabled. If the radio is on when the LOCK switch is moved to its up  Position, you will not be able to turn off. if the radio is off ,with the LOCKswitch in its up  position, you will not be able to turn it on. This will also prevent it from being turned on by accident, when packed in a attach case. To release the LOCKswitch, simply move the switch down.

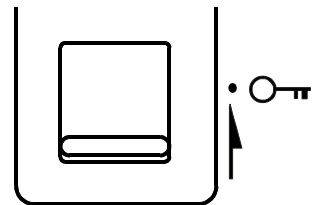

---

---

## EXTERNAL ANTENNA USE

To obtain optimum performance from this Unit, especially when listening to SW/SSB CW an external antenna should be used, if At all possible. The antenna is connected to The EXTERNAL ANTENNA ADAPTER and Then plugged into the EXTERNAL ANTENNA Jack located on the left side of the radio.

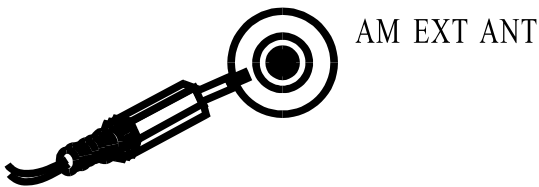

## MW STEP SELECTOR SWITCH

Located in battery compartment of the unit, Is a switch marked 9K/10K. This switch selects The incremental frequency STEPS for the MW Band, depending upon your geographic location. In the USA, 10K STEPS are used, so the switch Should be set to its 10K position. In other parts Of the world where they use 9K STEPS, move the switch to the 9K Position.

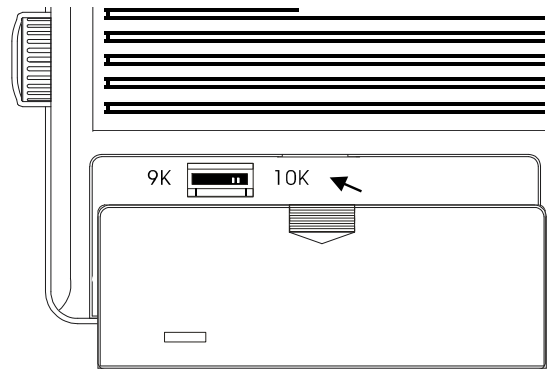

# SPECIAL SSB/CW RECEPTION TECHNIQUES

Many stations transmit unmodulated Telegraph transmissions in the shortwave Band .To receive these special Morse code Characters ,the radio uses a special circuit, A beat-frequency oscillator, to modify the Transmitted signal so that you can hear it. This particular type of telegraph trans- Mission is called continuous wave(CW) Transmission.

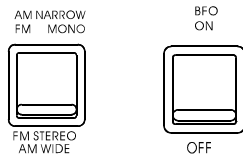

Many stations transmit voice signals with a Suppressed carrier in the single side band. (SSB),part of the radio transmission spectrum that lies to the side of the primary frequency signal. Many amateurs who operate transmit below 10 MHz generally use the lower side band(LSB).Above 10 MHz, they usually use the upper side band (USB).Commercial utility stations generally use the USB.A carrier has to be added to make these signals audible.

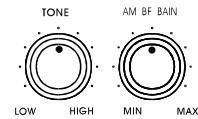

## TO RECEIVE CW

1. Turn on the radio.	
2. Extend the antenna fully straight up.	
3. Set the BFO switch to ON.	

4. Rotate the BFO PITCH control to the midpoint.

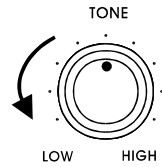

5. Rotate the RF GAIN control to the MAX position.

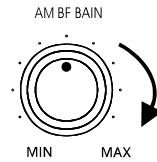

6. Press the SW band button to select the SW band.

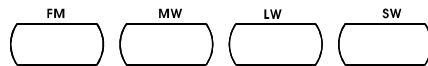

7. Tune in the CW station using the tuning knob, or enter the frequency using the direct access buttons.

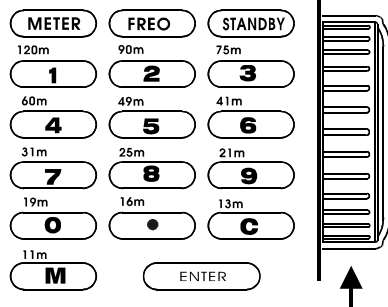

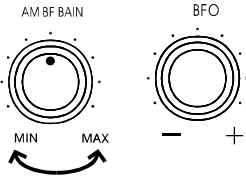
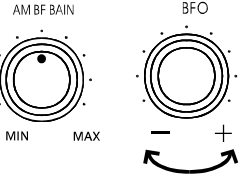
<p>8. Adjust the CW tone using the BFO PITCH control.</p>	 <p>The diagram shows two circular controls. The left one is labeled 'AM BF BAIN' and has 'MIN' and 'MAX' markings with a double-headed arrow below it. The right one is labeled 'BFO' and has '-' and '+' markings with a double-headed arrow below it.</p>
<p>9. Reduce strong signals by using the RF GAIN control. This also reduces Interference and noise.</p>	 <p>The diagram shows two circular controls. The left one is labeled 'AM BF BAIN' and has 'MIN' and 'MAX' markings. The right one is labeled 'BFO' and has '-' and '+' markings with a double-headed arrow below it.</p>

## TO RECEIVE SSB VOICE

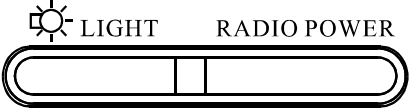
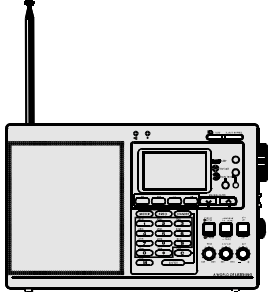
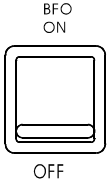
<p>1. Turn on the radio.</p>	 <p>The diagram shows two horizontal sliders. The left one has a sun icon and is labeled 'LIGHT'. The right one is labeled 'RADIO POWER'.</p>
<p>2. Extend the antenna fully, in a straight up position.</p>	 <p>The diagram shows a portable radio with its antenna extended upwards.</p>
<p>3. Set the BFO switch to the ON position.</p>	 <p>The diagram shows a rectangular switch with 'BFO ON' at the top and 'OFF' at the bottom. The 'ON' position is indicated by a horizontal line at the bottom of the switch.</p>

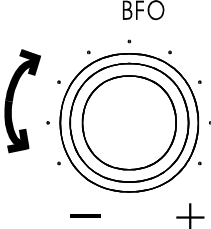
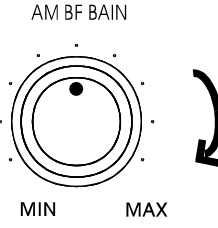
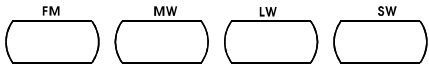
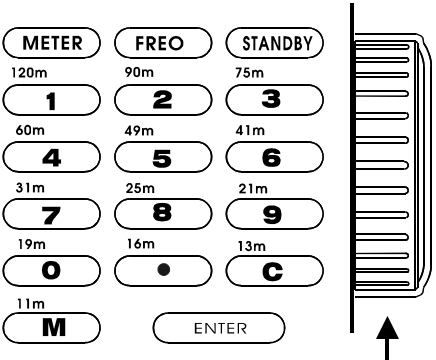

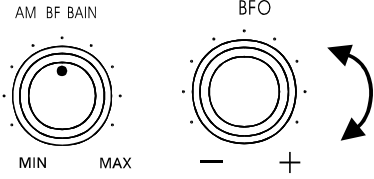
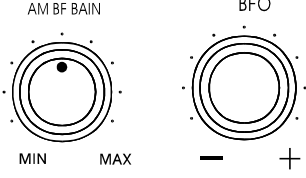
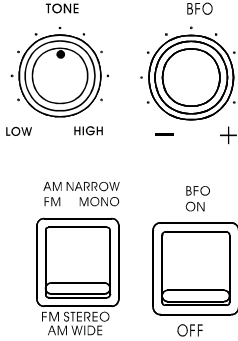

<p>4. Rotate the BFO PITCH control to the midpoint.</p>	
<p>5. Rotate the BF GAIN control to the MAX position.</p>	
<p>6. Press the SW button to select the SW band.</p>	
<p>7. Tune in the SSB station using the tuning knob, or enter the frequency using the direct access buttons.</p>	



<p>8. Rotate the BFO PITCH control to adjust the signal quality.</p>	
<p>9. Rotate the RF GAIN control dampen strong signals. This can improve signal clarity as well.</p>	
<p><b>Note:</b> Before choosing another band, set The RF GAIN control to MAX, and move the BFO switch to the OFF position.</p>	

# CARE AND MAINTENANCE

---

This receiver is an example of superior Design and craftsmanship. The following Suggestions will help you care for the Receiver so that you can enjoy it for years.

<p>Keep the product dry. If it does get wet, wipe It dry immediately. Liquids might contain Minerals that can corrode the electronic circuits.</p>	
<p>Use and store the product only in normal Temperature environments. High tempera- tures can shorten the life of electronic Devices, damage batteries, and distort or Melt plastic parts.</p>	
<p>Handle the product gently and carefully. Dropping it can damage circuit boards and Cases and can cause the product to work Improperly.</p>	
<p>Keep the product away from dust and dirt, Which can cause premature wear of parts.</p>	

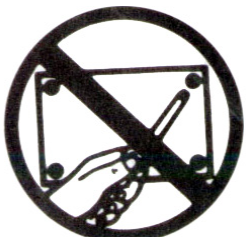
<p>Wipe the product with a dampened cloth Occasionally to keep it looking new. Do Not use harsh chemicals, cleaning solvents, Or strong detergents to clean to product.</p>	 A circular prohibition sign with a diagonal slash. Inside the circle, there is an illustration of a cleaning kit including a spray bottle, a bucket, and a sponge, with a puddle of liquid spilled on the surface below.
<p>Use only fresh batteries of the recommend-Ed size and type. Always remove old or Weak batteries. They can leak chemicals That destroy electronic circuits.</p>	 A circular prohibition sign with a diagonal slash. Inside the circle, there is an illustration of several old, leaking batteries with a mesh net draped over them, suggesting they should be removed or protected.
<p>Modifying or tampering with the product's Internal components can cause a malfunc- tion and might invalidate the product's warranty.</p>	 A circular prohibition sign with a diagonal slash. Inside the circle, there is an illustration of a hand using a screwdriver to tamper with the internal electronic components of a device.

# SPECIFICATIONS

---

Semi conductors: 1 LSI, 11IC,  
8FET, 46Transistors,  
49Diodes.

Circuit:

FM :Heterodyne  
AM(LW, MW SW) Double-conversion heterodyne

Frequency range:

FM: 87.5-108 MHz  
LW: 150-519 KHz  
MW: 520-1710 KHz  
SW: 1.711-29.999 MHz

In which divided into 13 shortwave bands

120m	2.300 - 2.495 MHz
90m	3.200 - 3.400 MHz
75m	3.900 - 4.000 MHz
60m	4.750 - 5.060 MHz
49m	5.950 - 6.200 MHz
41m	7.100 - 7.300 MHz
31m	9.500 - 9.900 MHz
25m	11.650 - 12.050 Mhz
21m	13.600 - 13.800 Mhz
19m	15.100 - 15.600 MHz
16m	17.550 - 17.900 MHz
13m	21.450 - 21.850 MHz
11m	25.670 - 26.100 MHz

Antennas:

LW/MW built-in Ferrite bar Antenna  
SW Telescopic Antenna or External Antenna (not included)  
FM Telescopic Antenna

Output: Nominal 800 mW at 10% T.H.D.

Jacks:

1.DC Jack for external power(6v)  
2.Headphone jack-3.5 for mini stereo headphones  
3.AM Ext. Ant . Jack.

---

**Power sources:**

DC 4 each “D” size batteries.

3 each “AA” size batteries

AC:6 volt DC (optional adapter negative center)

**Dimension:**

296(L) 192(H) 68(T)mm

**Weight:**

2000g without batteries.

**Accessories:**

Adaptor (except for certain areas like United Kingdom, New Zealand, Australia, South Africa, etc.)